

MF205 Connector

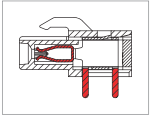

DIMENSIONS/POSITIONS

MF205-508

間距	Pitch	5.08mm
位數	Poles	2 ~ 24Poles
塑膠本體	Housing Material	PA 66
夾片	Wire Protector	Phosphor Bronze, Tin Plated
PCB孔徑	PCB Hole Diameter	1.4mm
環境作業溫度	Operating Temperature	-40°C to +105°C

TECHNICAL DATA

連接符合標準 Connection in acc. with standard EN-VDE		
額定電流 I _n Nominal Current I _n		11A
額定橫截面 Nominal Cross Section		-
最大負載電流 Maximum load current		11A
絕緣材料 Insulating Material		PA
阻燃等級,符合UL94 Inflammability class acc. to UL94		V0
額定電壓,UL/CUL Nominal voltage, UL/CUL		300V
額定電流,UL/CUL Nominal current, UL/CUL		11A

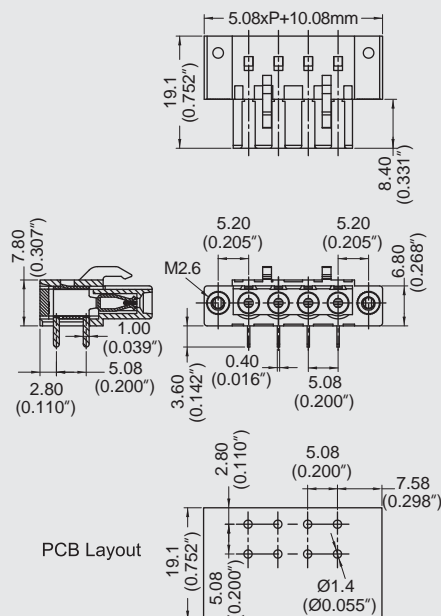

MF